

TEES

TEES - SQUARE FILLET TOES

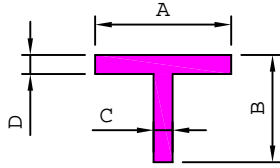

SL. No.	Section No.	A	B	C	D	Weight kg/m
1	17720	9.00	30.50	7.00	9.00	0.625
2	16134	11.50	11.50	0.58	0.58	0.035
3	16127	12.70	12.70	0.56	0.56	0.038
4	16157	12.70	12.70	0.72	0.72	0.048
5	16102	12.70	12.70	1.70	1.70	0.109
6	16135	17.00	17.00	0.51	0.51	0.046
7	16141	18.80	18.80	2.00	2.00	0.192
8	16139	18.80	18.80	2.30	2.30	0.219
9	16128	19.05	19.05	0.66	0.66	0.067
10	16143	19.05	19.05	1.00	1.00	0.100
11	16103	19.05	19.05	1.45	1.45	0.144
12	16104	19.05	19.05	3.18	3.18	0.299
13	16142	21.70	22.50	1.80	1.80	0.206
14	16144	24.00	24.00	0.73	0.73	0.093
15	16153	24.00	27.00	10.50	6.00	0.984
16	16140	24.00	31.00	4.40	4.40	0.601
17	16154	25.00	15.00	1.00	1.00	0.105
18	16159	25.00	29.00	3.90	3.80	0.521
19	16131	25.40	25.40	0.83	0.83	0.111
20	16129	25.40	25.40	1.22	1.22	0.163
21	16108	25.40	25.40	1.60	1.60	0.212
22	16125	25.40	25.40	2.60	2.60	0.338
23	28242	27.50	16.00	11.00	3.00	0.608
24	16158	28.00	16.00	3.00	8.00	0.507
25	16152	31.00	19.35	1.75	1.75	0.229
26	16111	31.75	31.75	1.60	1.60	0.267
27	16112	31.75	38.10	1.60	1.60	0.294
28	28058	35.50	66.50	12.50	7.00	2.679
29	16136	38.00	38.00	2.00	2.00	0.400
30	16155	38.10	38.10	1.50	1.50	0.302
31	16118	38.10	38.10	1.60	1.60	0.322
32	16115	38.10	38.10	3.18	3.18	0.627
33	16121	38.10	38.10	4.80	4.80	0.925
34	16145	38.61	76.20	6.35	6.35	1.859
35	27927	41.30	41.30	23.30	6.00	2.889
36	28076	41.30	42.30	22.20	6.00	2.845
37	16146	50.80	76.20	6.35	6.35	2.068
38	16150	50.80	152.40	6.35	6.35	3.375
39	28056	52.00	66.50	31.00	7.00	5.963
40	16156	98.42	50.80	3.18	3.18	1.252

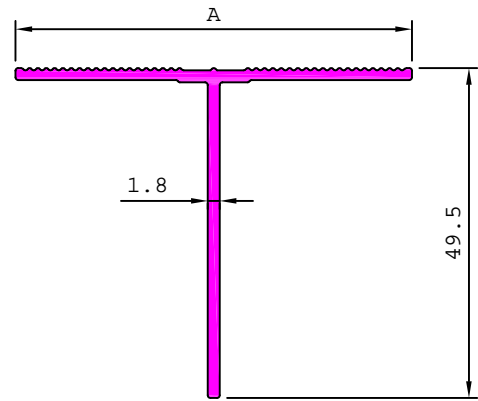

SL. No.	Section No.	A	Weight kg/m
1	22965	59.50	0.498
2	22978	79.50	0.586
3	22977	99.50	0.674
4	22966	119.50	0.761

TEES

TEES - ROUND FILLET TOES

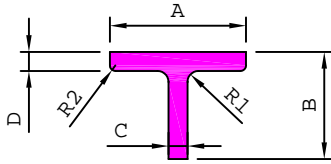

SL. No.	Section No.	A	B	C	D	R1	R2	Weight kg/m
1	16160	23.80	22.65	1.80	1.80	2.00	0.40	0.221
2	16305	24.50	24.00	2.07	2.07	1.00	-	0.260
3	16304	24.50	24.00	2.40	2.40	2.50	-	0.306
4	16161	24.50	24.00	2.50	2.50	2.00	0.40	0.315
5	16303	24.50	24.65	2.70	3.00	2.75	-	0.364
6	16301	25.40	25.40	3.18	3.18	4.57	3.00	0.422
7	16311	30.00	105.00	3.00	3.00	2.00	-	1.073
8	16312	39.00	38.00	5.00	3.60	0.40	2.00	0.839
9	16310	50.00	50.00	5.00	5.00	4.00	-	1.300
10	16309	80.00	235.00	6.50	10.00	4.00	1.00	6.124

BULBED TEES - STRAIGHT HEAD

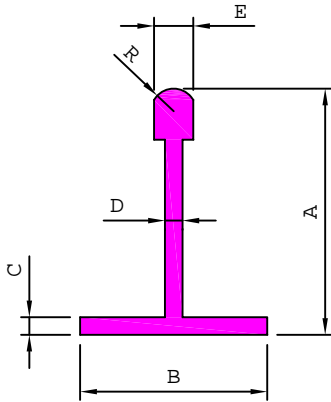

SL. No.	Section No.	A	B	C	D	E	R	Weight kg/m
1	17219	23.50	23.50	0.90	0.90	2.70	-	0.122
2	17210	23.50	23.50	1.20	1.20	3.00	-	0.171
3	17204	23.50	23.50	1.50	1.50	3.00	-	0.202
4	17222	25.00	24.50	0.45	0.45	1.80	-	0.066
5	17209	25.00	24.50	0.59	0.59	2.05	-	0.085
6	17213	25.00	24.50	0.65	0.65	2.30	-	0.097
7	17212	25.00	24.50	0.95	0.95	2.50	-	0.136
8	17217	25.00	24.50	0.74	0.74	2.50	-	0.109
9	17211	25.00	25.00	1.17	1.17	3.50	-	0.171
10	17214	25.00	25.00	1.35	1.35	3.50	-	0.195
11	17216	25.00	25.00	1.60	1.60	3.50	-	0.219
12	17218	25.45	40.00	1.45	1.45	2.80	1.40	0.258
13	17203	30.00	30.00	1.60	1.50	2.80	2.50	0.254
14	17215	32.00	32.00	1.45	1.45	2.80	2.50	0.254
15	17206	32.00	32.00	1.60	1.60	2.80	2.50	0.278
16	17208	35.00	23.50	1.50	1.50	3.00	-	0.249
17	17205	36.50	23.50	1.50	1.50	3.00	-	0.254
18	17221	38.00	25.00	1.40	1.40	2.80	1.40	0.249
19	17220	38.00	38.00	1.40	1.40	5.00	2.50	0.329
20	17201	38.10	38.10	1.50	1.60	5.10	2.55	0.357
21	17207	50.80	38.10	1.50	1.50	4.00	-	0.381
22	17202	63.50	38.10	2.03	1.60	5.10	2.55	0.519

BULBED TEES - TAPERED HEAD

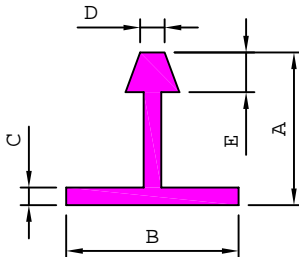

SL. No.	Section No.	A	B	C	D	E	Weight kg/m
1	17304	36.50	25.00	1.10	2.80	2.80	0.195
2	17302	36.50	25.00	1.60	2.80	2.80	0.270

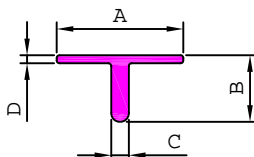

SL. No.	Section No.	A	B	C	D	Weight kg/m
1	17626	12.90	6.60	3.00	1.50	0.091
2	17593	13.00	8.00	2.65	1.20	0.088
3	17591	15.90	8.00	2.75	1.20	0.099
4	17592	19.00	10.00	2.65	1.20	0.122

TEES

29589

1.498 kg/m

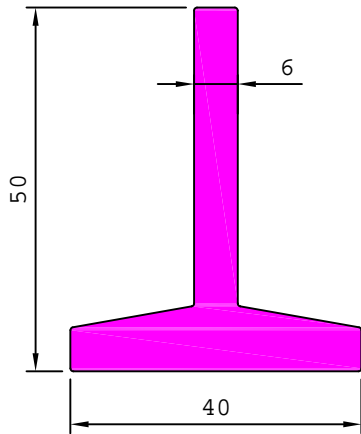

29590

3.118 kg/m

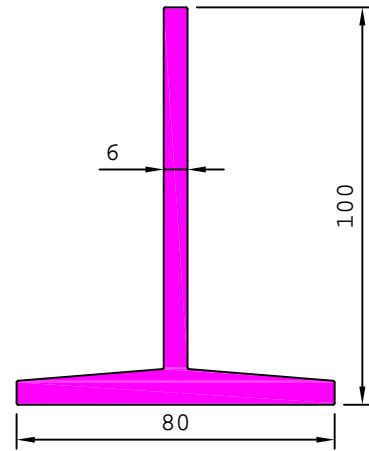

29561

3.747 kg/m

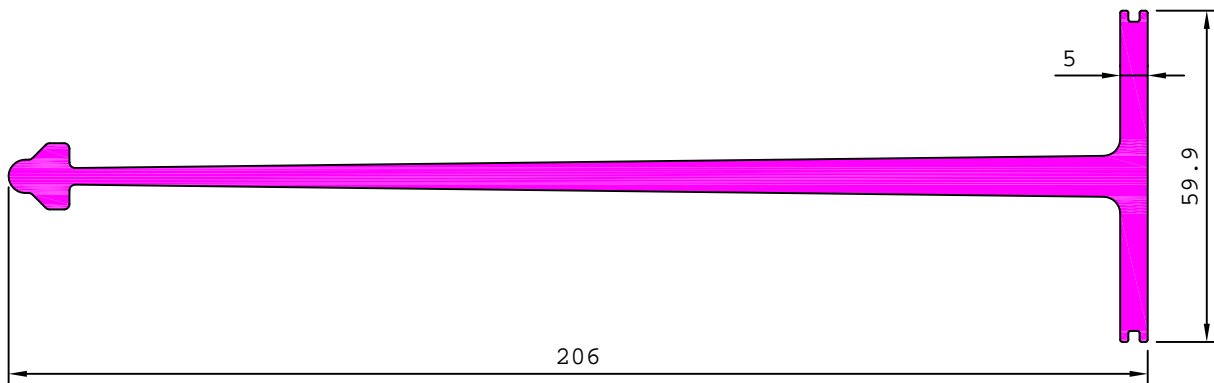

17691

2.243 kg/m

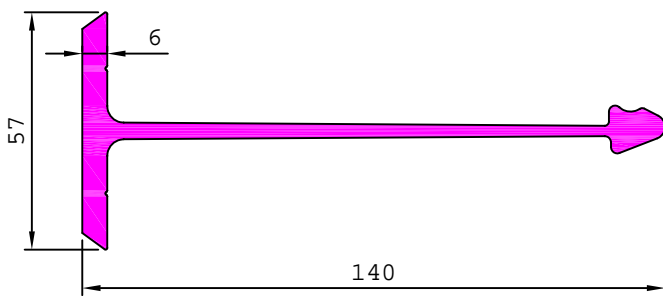

17692

2.024 kg/m

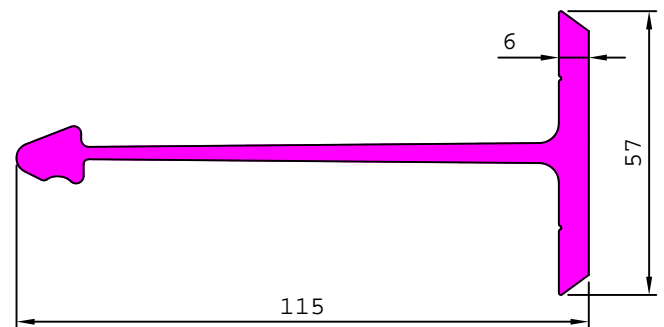

17694

0.736 kg/m

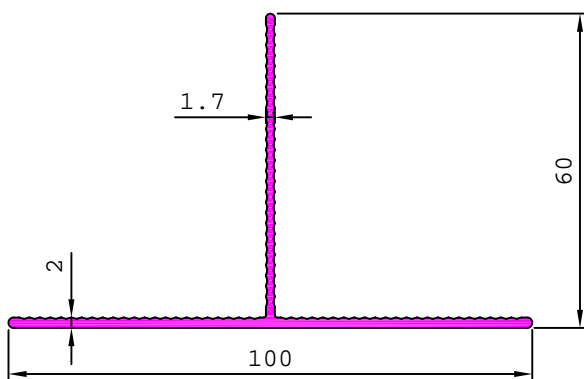

S4295

1.113 kg/m

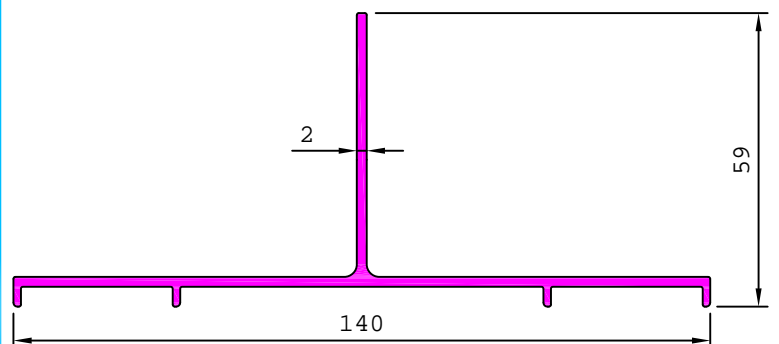

TEES

17718

0.853 kg/m

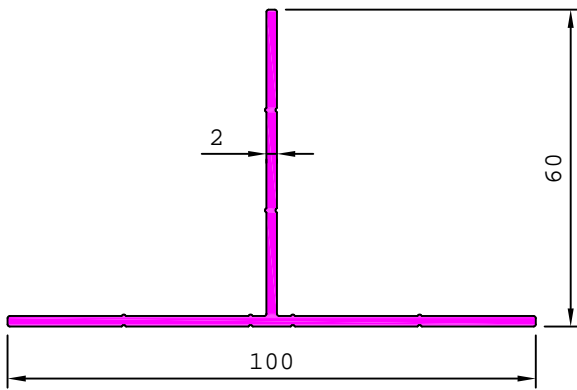

17725

1.121 kg/m

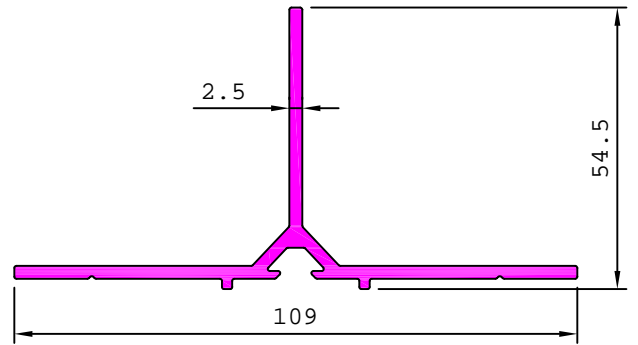

S4161

2.546 kg/m

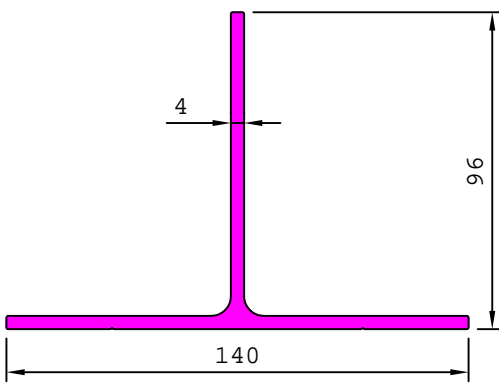

22943

0.820 kg/m

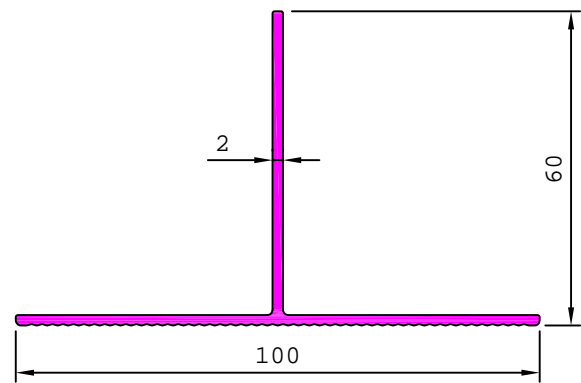

17738

0.088 kg/m

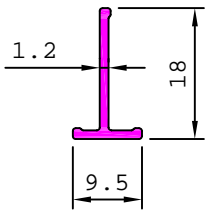

17102

0.212 kg/m

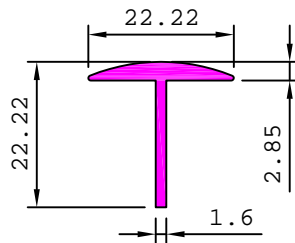

17730

0.135 kg/m

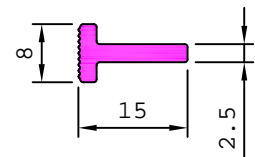

17502

0.036 kg/m

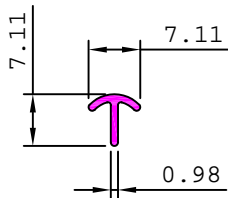

S5506

0.863 kg/m

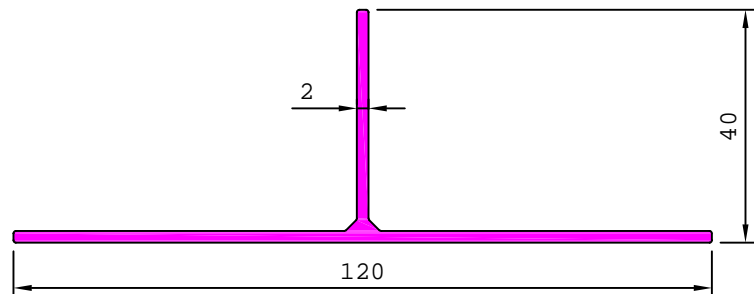

TEES

S5624

0.836 kg/m

16313

0.820 kg/m

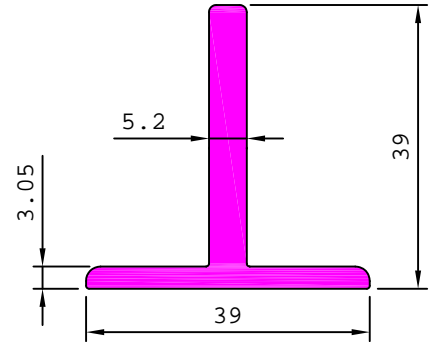
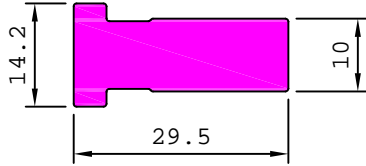

S6255

2.397 kg/m

